

CPCI Case System 6/7 U

User's Manual



Product No.:
24579-612

Rev.	Date updated	Change
R1.0	February 16, 2009	Initial Release
R1.1	December 16, 2010	New ATX PSU, ECN 10/2345

Impressum:

Schroff GmbH

D-75334 Straubenhardt, Germany

The details in this manual have been carefully compiled and checked.

The company cannot accept any liability for errors or misprints. The company reserves the right to amendments of technical specifications due to further development and improvement of products.

Copyright © 2010

All rights and technical modifications reserved.

Table of Contents

1	Safety	1
1.1	Intended Application	1
1.2	Safety Instructions	2
1.2.1	Safety Symbols used in this document	2
1.3	General Safety Precautions	2
2	Product Definition	3
2.1	References and Architecture Specifications	3
2.2	Case System Overview	3
2.3	Subrack	4
2.4	CPCI Backplane	4
2.5	Power Supply	5
2.5.1	ATX Power Supply	5
2.5.2	Grounding/Earthing	5
2.6	Cooling	6
3	Installation	7
3.1	General Installation Guidelines	7
3.1.1	Unpacking	7
3.1.2	Ensuring Proper Airflow	7
3.2	Initial Operation	7
4	Service	8
4.1	Technical support and Return for Service Assistance	8
4.2	Declaration of Conformity	8
4.3	Scope of Delivery	9
4.4	Accessories	9
4.5	Spare Parts	9
5	Technical Data	10
6	Dimensions	11

1 Safety

1.1 Intended Application

The CompactPCI (CPCI) system, described in this manual, is intended as a platform for a microcomputer system based on the CompactPCI Standard PICMG 2.0 Rev.3.

The CPCI case systems are designed for protection class IP 20 and can be used only in the resp. environments.

CPCI system subracks are not end-products, so there is no valid approval for this unit. In order to enable stand-alone functionality, additional elements are required. An operational system is achieved only by way of appropriate CPCI boards.

The completion and final testing of the units have been carried out, or at least supervised, by qualified technicians. These instructions are directed exclusively to these qualified technicians i.e. engineers, trained and qualified electricians etc.



Make sure that:

- the finished system complies with the safety regulations currently applicable in the country it is going to be used.
- the finished system complies with all other regulations and specifications at the place and country of use, e.g. interference limits, approval by the telecommunications authorities.

1.2 Safety Instructions

The intended audience of this User's Manual is system integrators and hardware/software engineers.

1.2.1 Safety Symbols used in this document

	<p>Hazardous voltage!</p> <p><i>This is the electrical hazard symbol. Familiarise yourself with the danger of electrical voltages and the safety precautions to avoid accidents before starting to work with parts that carry dangerous voltages.</i></p>
	<p>Caution!</p> <p><i>This is the user caution symbol. It indicates a condition where damage of the equipment or injury of the service personnel could occur. To reduce the risk of damage or injury, follow all steps or procedures as instructed.</i></p>
	<p>Danger of electrostatic discharge!</p> <p><i>Static electricity can damage sensitive components in a system. To avoid damage, wear ESD wrist straps or at regular intervals touch blank enclosure parts.</i></p>

1.3 General Safety Precautions

	<p>Warning!</p> <p><i>Voltages over 60 VDC can be present in this equipment. This equipment is intended to be accessed, to be installed and maintained by qualified and trained service personnel only.</i></p> <p><i>This equipment is designed in accordance with protection class 1! It must therefore be operated only with protective GND/earth connection!</i></p>
---	---

- Service personnel must know the necessary electrical safety, wiring and connection practices for installing this equipment.
- Install this equipment only in compliance with local and national electrical codes.

2 Product Definition

The Schroff CPCI case system consists of:

- A shielded ratiopacPRO-air case with front and rear card cage for 6 U boards according to CompactPCI Standard PICMG 2.0 Rev.3
- An 8 slot 6 U CPCI Backplane (64-bit), system slot right
- 2 radial Fans for the active cooling of the boards
- An ATX power supply (300 W) with wide range input, IEC320-C14 connector and mains/line switch
- Drive holder for an optional 5.25" DVD drive

2.1 References and Architecture Specifications

- User Manual CPCI Backplanes
Order no.: 73972-101
- User Guide Schroff CPCI Backplanes 23006-868
Order no.: 73972-075

Further information can also be found in the catalogue „Electronic Packaging“ and on the internet under www.schroff.biz

2.2 Case System Overview

Figure 1: Case System Overview



12309822

- | | | | |
|---|--|---|----------------------------------|
| 1 | Front panel 6 U, 16 HP | 4 | CPCI Backplane |
| 2 | Drive holder for an optional 5.25" DVD drive | 5 | Front panel 6 U, 4 HP |
| 3 | ATX Power Supply | 6 | Front Card cage with guide rails |

2.3 Subrack

The 7 U case is based on the Schroff ratiopacPRO-air system with EMC shielding. The card cage enables the assembly of 8 CPCI front boards (6 U, 4 HP, 160 mm deep) and 8 Rear I/O Boards (6 U, 4 HP, 80 mm deep).

The lower guide rails of the card cage are equipped with ESD clips.



Variations

The Schroff assembly service can customize your system with:

- *Different Backplane configurations*
- *Drive mounting cassettes*
- *Special power supplies*

More information in the catalogue or at www.schroff.biz

2.4 CPCI Backplane

The 6 U/ 8 slot Backplane provides:

- CompactPCI bus 64 bit (PICMG2.0 R.3.0) with System Slot right
- System slot expandable from 4 HP to 8 HP
- Rear I/O on P2, P4 and P5
- V(I/O) 5 V (adjustable to 3.3 V)
- Bridge connector for secondary Backplane

Applicable Specifications:

PICMG 2.0 R3.0 CPCI Core Specification



PICMG 2.01 R2.0 Hot Swap

PICMG 2.09 R1.0 System Management Bus

PICMG 2.10 R1.0 Keying

More information in the manual for the backplane order no.: 73972-075

2.5 Power Supply

	<p>Hazardous voltage!</p> <p><i>Parts of the power supply may be exposed with hazardous voltage. Always remove mains/line connector before carry out any assembly work.</i></p>
	<p>Caution!</p> <p><i>Your system has not been provided with a AC power cable. Purchase a AC power cable that is approved for use in your country. The voltage and current rating of the AC power cable should be greater than the ratings marked on on the product's electrical ratings label.</i></p>

Power is provided through a 300 W ATX power supply with wide range input, IEC 320-C14 connector and mains on/off switch. The power supply is located at the front to the left of the card cage behind a front panel.

2.5.1 ATX Power Supply

Table 1: Techn. Data

Input voltage	90 ... 264 VAC, active PFC
Input frequency	47...63 Hz
Input current	5 A (115 V) / 2,5 A (230 V)
Output (max)	5 V / 35 A; 3,3 V / 28 A, 12 V / 22 A, -12 V / 0,8 A)
Output (min)	5 V / 0,5 A; 3,3 V / 0 A, 12 V / 0,5 A, -12 V / 0,0 A)
Inrush Current	44/87 A (115/230 VAC)
Efficiency	>70%/75% (115/230 VAC)
Overload protection	110...150%, switch-off
Overvoltage protection	+3,3 V (+3,9...+4,3 V), +5 V (+5,7...+6,5 V), +12 V (+13,6...+15 V)
Ripple	+3,3 V 50 mV / +5 V 50 mV / +12 V 120 mV / -12 V 150 mV
Load regulation	+3,3 V ±5% / +5 V ±5% / +12 V +7/-5% / -12 V ±5%
Hold up time	>16 msec.
Power Good Signal	Power on delay 100...500 msec, Power off delay 1 msec.
Insulation Voltage	Input/Chassis 3100 VDC, Input/Output 4242 VDC.
Earth Leakage Current	<3,5 mA (115/230 VAC)
Operating temperature	-10...+70 °C
Derating	From 50...+70 °C 1%/°C
Storage temperature	-20...+80 °C
Humidity	10...90% RH, non-condensing
MTBF	>100.000 h at +50 °C, without fan
Safety	EN 60950 / UL 60950
EMV	CE
Fan	Ball bearing fan
Dimensions	140 x 150 x 86 mm, ±0,5mm

Combined max. output current at +3.3 V and +5 V must not exceed 45 A. For temperatures <20°C a higher min. output current is required.

2.5.2 Grounding/Earthing

	<p>Caution!</p> <p><i>The unit is designed in accordance with protection class 1! It must therefore be operated with protective earth/GND connection. Use only a three conductor AC power cable with a protective earth conductor that meets the IEC safety standards!</i></p>
---	---

2.6 Cooling

The CPCI boards are cooled by forced air convection through two 12 VDC radial fans (36 m³/h (21 cfm)).

The operating temperature is from 0°C to 50°C.



Caution!

To maintain proper airflow, all open slots must be covered with filler panels. The filler panel should include an airflow baffle that extends to backplane.

Figure 2: Airflow

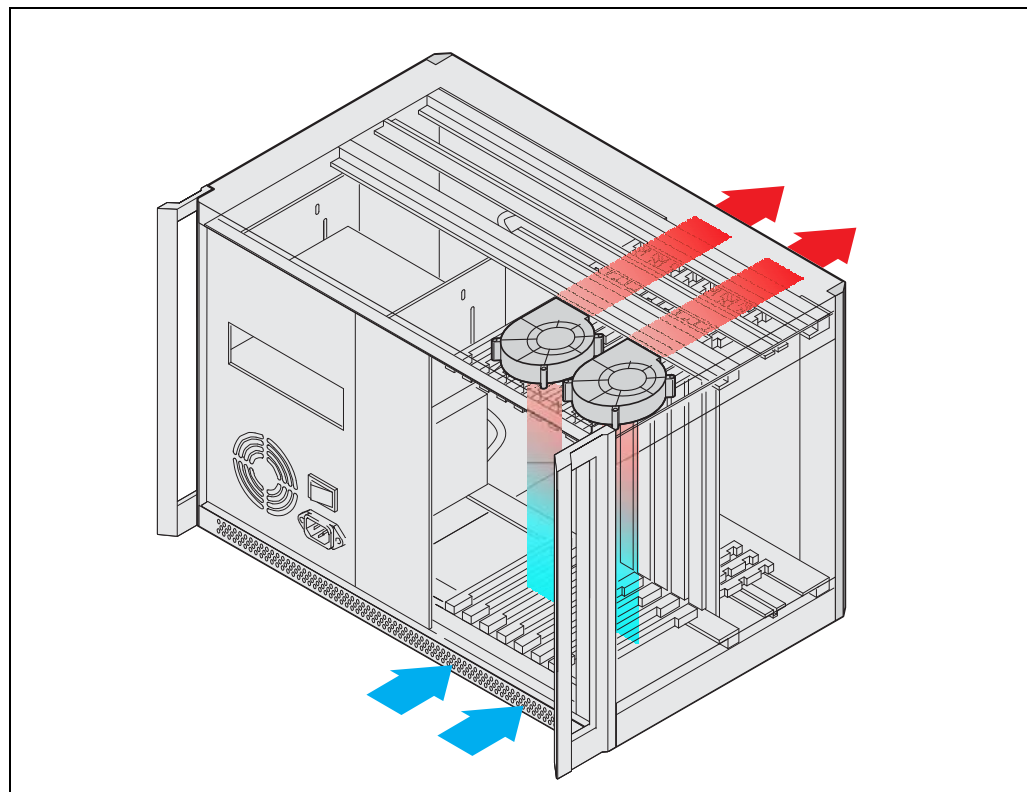

12309821

3 Installation

3.1 General Installation Guidelines

3.1.1 Unpacking

	<p>Caution! <i>When opening the shipping carton, use caution to avoid damaging the system.</i></p>
---	---

Consider the following when unpacking and storing the system:

- Leave the system packed until it is needed for immediate installation.
- After unpacking the system, save and store the packaging material in case the system must be returned.

If the packaging is damaged and possible system damage is present, report to the shipper and analyze the damage.

3.1.2 Ensuring Proper Airflow

- Maintain ambient airflow to ensure normal operation. If the airflow is blocked or restricted, or if the intake air is too warm, an over temperature condition can occur.
- Ensure that cables from other equipment do not obstruct the airflow through the systems.
- Use filler panels to cover all empty chassis slots. The filler panel should include an airflow baffle that extends to backplane. The filler panel prevents fan air from escaping out of the front of an open slot.

3.2 Initial Operation

	<p>Warning! <i>This equipment is intended to be accessed, to be installed and maintained by qualified and trained service personnel only. This equipment is designed in accordance with protection class 1! It must therefore be operated only with protective GND/earth connection!</i></p>
---	---

- Ensure that the system has not been damaged during transport, storage or assembly.
- Check the Protective Earth (PE) resistance, should be < 0,1 Ohm.
- Switch on the system and check all CPCI voltages directly on the backplane connectors before the board assembly.
Note: The ATX power supply requires a minimum load!
- Plug-in the boards
- Cover all open Slots with filler panels.

4 Service

4.1 Technical support and Return for Service Assistance

We generally recommend to return the complete system. For all product returns and support issues, please contact your Schroff sales distributor or www.schroff.biz.

We recommend that you save the packing material. Shipping without the original packing material might void the warranty.

4.2 Declaration of Conformity

SCHROFF CompactPCI systems are developed and manufactured according to EN 60950-1.

SCHROFF CompactPCI systems are not end-products with independent functionality as described in the definition of the EMC regulations, and therefore a CE marking is not required. However, when CPCI cards are assembled according to specification, the systems fulfill the requirements in accordance with EMC Directive 2004/108/EG and Low-voltage Directive 2006/95/EG.

Interference resistance and interference emissions are factors which are heavily influenced by the type and quantity of CPCI cards used in the system assembly. Through the use of high quality line filters and EMC optimized enclosure design, SCHROFF offers CPCI systems which serve as an ideal base for system integrators, which comply with the prescribed limits of EN 6100-6-3 and EN 61000-6-2

The systems are generally equipped with power supplies which possess CE markings in accordance with EN 60950-1, EN 61000-6-3, EN 61000-6-2).

Before delivery a high-voltage, protective earth and functionality test is carried out on each individual system.

4.3 Scope of Delivery

Quantity	Description
1	Shielded ratiopacPRO-air case 7 U / 84 HP with front handles
1	CPCI backplane (PICMG2.0 R.3.0), 8 slot 6 U
1	Front card cage for max. 8 boards 6 U 160 mm deep IEEE guide rails inc. ESD clips)
1	Rear card cage for max. 8 boards 6 U 80 mm deep IEEE guide rails inc. ESD clips
2	Radial fans 36 m³/h (21 CFM) each
1	300 W ATX power supply with input range of 100 VAC to 240 VAC, IEC320-C14 connector and mains/line switch. w4 voltages: 3,3 V / 28 A; 5 V / 35 A; 12 V / 22 A; -12 V / 0,8 A)
1	Complete AC/DC cabling
1	Drive holder for a 5.25" DVD drive
1	Front panel 6 U, 4 HP (Front)
1	Front panel 6 U, 4 HP (Rear)
1	Front panel 6 U, 16 HP (Front)
1	Front panel 6 U, 48 HP (Rear)

Please order the power cable separately.

4.4 Accessories

Order No.	Description
20848-75x	Front panels for Rear I/O Boards, dimensions see catalogue
20848-7xx	Slot covers with front panel and EMC shielding for vacant slots. For dimensions, please see catalogue.
34562-8xx	Slot covers for vacant slots. For dimensions, please see catalogue.
24579-03x	Printed Circuit Board covers (solder side covers). For dimensions, please see catalogue

4.5 Spare Parts

On request.

5 Technical Data

Table 2: Technical Data

Dimensions	
Height (w/o feet)	310,25 mm (7 U)
Height (with feet)	325,50 mm
Width (w/o handles)	448,90 mm
Width (with handles)	462,10 mm
Depth (Card cage)	275 mm
Depth (Overall with handles)	340,43 mm
Weight	
Completely assembled	approx. 9.5 kg
Power Supply	
Input Voltage	100 VAC to 240 VAC
Frequency	50 / 60 Hz
Power input	up to 300 W
Cooling	
2 x 12 VDC radial fans	36 m ³ /h (21 cfm) each, free blow
Ambient Temperature	
Operation	+0 °C to +50 °C
Storage	-40 °C to +85 °C
Humidity	
Admissible humidity	30 % to 80 %, non-condensing
EMC, fulfils requirements for:	
Transient Emissions	EN 61000-6-3
Interference Resistance	EN 61000-6-2
Safety	
Test voltages according to EN 60950	Input - Output: 4,3 kVDC Input - PE: 2,2 kVDC Output - PE: 0,7 kVDC Output - Output: 0,7 kVDC
Shock and vibration:	EN 60068-2-6 and EN 60068-2-27
Electromagnetic Shielding	
Shielding attenuation	typ. 40 dB at 1 GHz if shielded front panels are used.

6 Dimensions

Figure 3: Dimensions

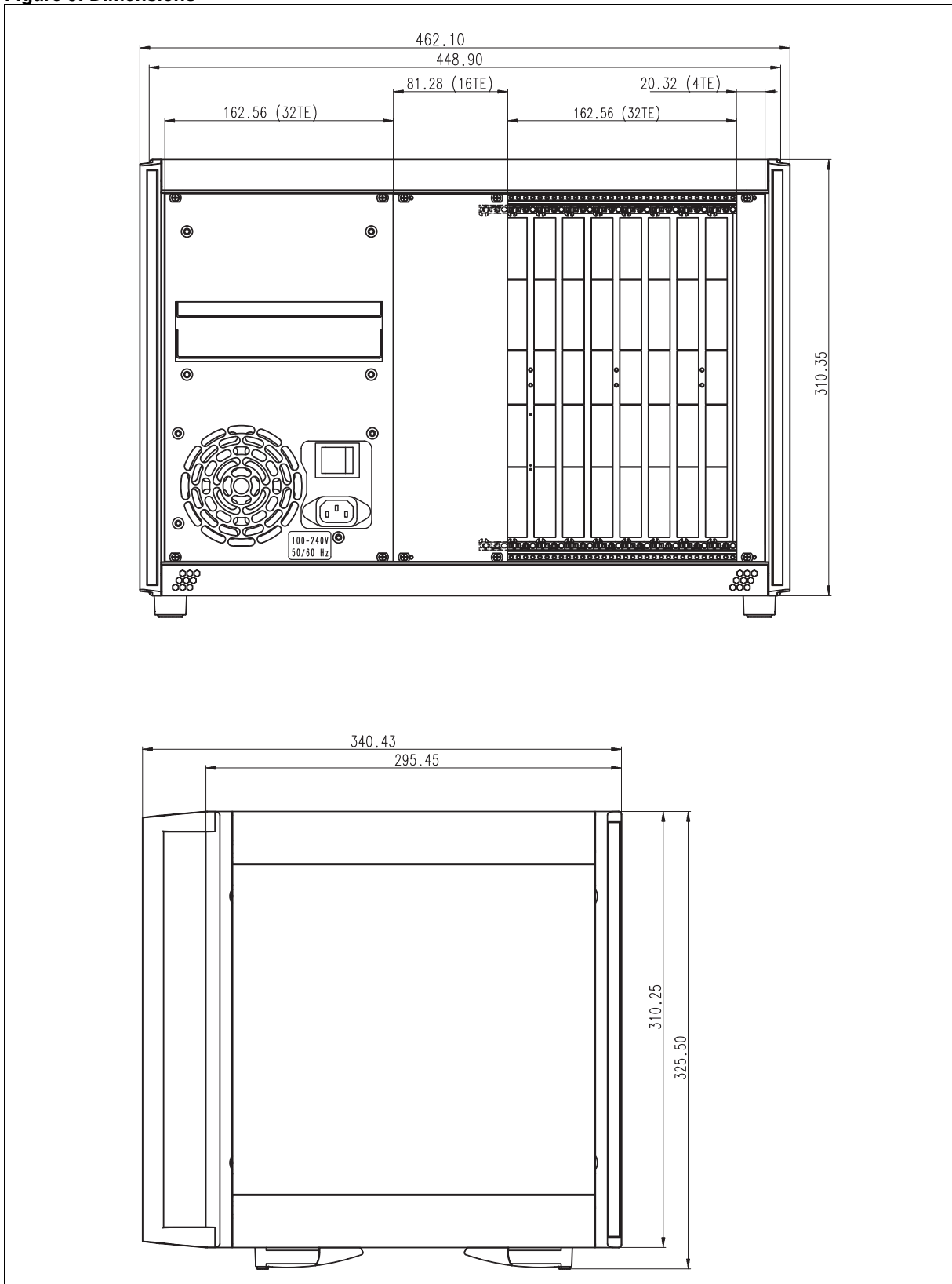



SCHROFF GMBH

**Langenalberstr. 96-100
D-75334 Straubenhardt**

www.schroff.biz

Tel.: + 49 (0) 7082 794-0

Fax: +49 (0) 7082 794-200